

USER'S MANUAL

SOLAR INVERTER

8KW-12KW



<https://tuncmatik.com/indirme-merkezi/>

Appliances



PC



TV



Air-
conditioning



Fridge



Washing
machine

Table of Contents

ABOUT THIS MANUAL	1
Notice.....	1
Purpose	1
Scope	1
SAFETY INSTRUCTIONS	1
INTRODUCTION	2
Features.....	2
Basic System Architecture.....	2
Product Overview.....	3
INSTALLATION	4
Unpacking and Inspection.....	4
Preparation.....	4
Mounting the Unit.....	4
Battery Connection.....	5
AC Input/ Output Connection.....	6
PV Connection	7
PV Module Selection.....	8
Conditions for DC Connection.....	9
Final Assembly.....	10
Communication Connection.....	10
Dry Contact Signal.....	10
OPERATION	11
Power ON/OFF.....	11
Operation and Display Panel.....	11
LCD Display Icons.....	12
LCD Setting.....	14
Fault Reference Code.....	20
Warning Indicator.....	21
Operating Mode Description.....	22
Display Setting.....	23
SPECIFICATIONS	23
Table 1 Line Mode Specifications.....	23
Table 2 Inverter Mode Specifications.....	24
Table 3 Charge Mode Specifications.....	25
Table 4 General Specifications.....	26
TROUBLE SHOOTING	27

ABOUT THIS MANUAL

Notice

The purchased products, services and features are stipulated by the contract made between supplier and the customer. All or part of the products, services and features described in this document may not be within the purchase scope or the usage scope.

Unless otherwise specified in the contract, all statements, information, and recommendations in this document are provided "AS IS" without warranties, guarantees or representations of any kind, either express or implied.

The information in this document is subject to change without notice. Every effort has been made in the preparation of this document to ensure accuracy of the contents, but all statements, information, and recommendations in this document do not constitute a warranty of any kind, express or implied.

Purpose

This manual describes the assembly, installation, operation and troubleshooting of this unit. Please read this manual carefully before installations and operations. Keep this manual for future reference.

Scope

This manual provides safety and installation guidelines as well as information on tools and wiring.

The following cases are not within the scope of warranty

1. Out of warranty.
2. Series number was changed or lost.
3. Battery capacity was declined or external damaged.
4. Inverter was damaged caused of transport shift, remissness, ect external factor
5. Inverter was damaged caused of irresistible natural disasters.
6. Not in accordance with the electrical power supply conditions or operate environment caused damage.

SAFETY INSTRUCTIONS



WARNING: This chapter contains important safety and operating instructions. Read and keep this manual for future reference.

1. Before using the unit, read all instructions and cautionary markings on the unit the batteries and all appropriate sections of this manual.
2. **CAUTION** --To reduce risk of injury, charge only deep-cycle lead acid type rechargeable batteries. Other types of batteries may burst, causing personal injury and damage.
3. Do not disassemble the unit. Take it to a qualified service center when service or repair is required. Incorrect re-assembly may result in a risk of electric shock or fire.
4. To reduce risk of electric shock, disconnect all wirings before attempting any maintenance or cleaning. Turning off the unit will not reduce this risk.
5. **CAUTION** --Only qualified personnel can install this device with battery.
6. **NEVER** charge a frozen battery.
7. For optimum operation of this inverter/charger, please follow required spec to select appropriate cable size. It's very important to correctly operate this inverter/charger.
8. Be very cautious when working with metal tools on or around batteries. A potential risk exists to drop a tool to spark or short circuit batteries or other electrical parts and could cause an explosion.
9. Please strictly follow installation procedure when you want to disconnect AC or DC terminals. Please refer to INSTALLATION section of this manual for the details.
10. Fuse(1 piece of 200A/63VDC for 8KW model,2 pieces of 150A/63VDC parallel for 10-12KW model) is provided as over-current protection for the battery supply.
11. GROUNDING INSTRUCTIONS- This inverter/charger should be connected to a permanent grounded wiring system. Be sure to comply with local requirements and regulation to install this inverter.
12. NEVER cause AC output and DC input short circuited. Do NOT connect to the mains when DC input short circuits.
13. **Warning!!** Only qualified service persons are able to service this device. If errors still persist after following troubleshooting table, please send this inverter/charger back to local dealer or service center for maintenance.

INTRODUCTION

This is a multi-function inverter/charger, combining functions of inverter, solar charger and battery charger to offer uninterruptible power support with portable size. Its comprehensive LCD display offers user-configurable and easy-accessible button operation such as battery charging current, AC/solar charger priority, and acceptable input voltage based on different applications.

Features

- Pure sine wave inverter
- Configurable input voltage range for home appliances and personal computers via LCD setting
- Configurable battery charging current based on applications via LCD setting
- Configurable AC/Solar Charger priority via LCD setting
- Compatible to mains voltage or generator power
- Auto restart while AC is recovering
- Overload/ Over temperature/ short circuit protection
- Smart battery charger design for optimized battery performance
- Cold start function

Basic System Architecture

The following illustration shows basic application for this inverter/charger. It also includes following devices to have a complete running system:

- Generator or Utility.
- PV modules (option)

Consult with your system integrator for other possible system architectures depending on your requirements.

This inverter can power all kinds of appliances in home or office environment, including motor-type appliances such as tube light, fan, refrigerator and air conditioner.

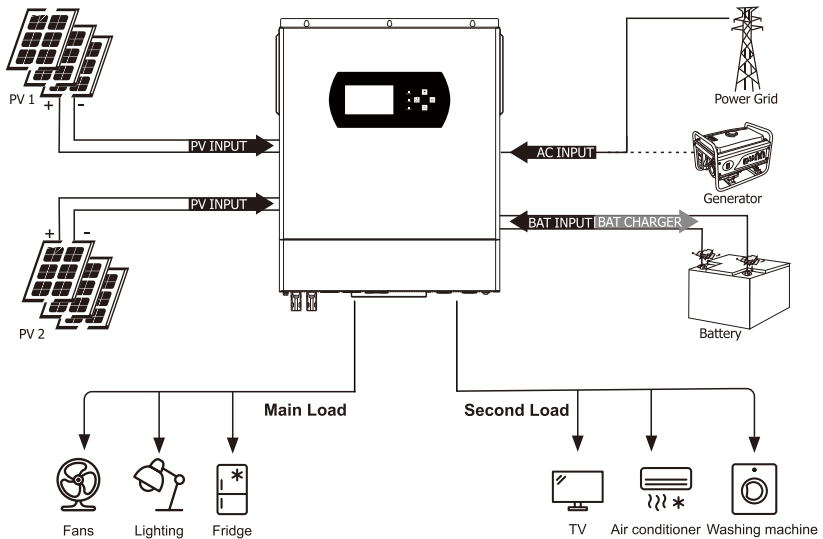
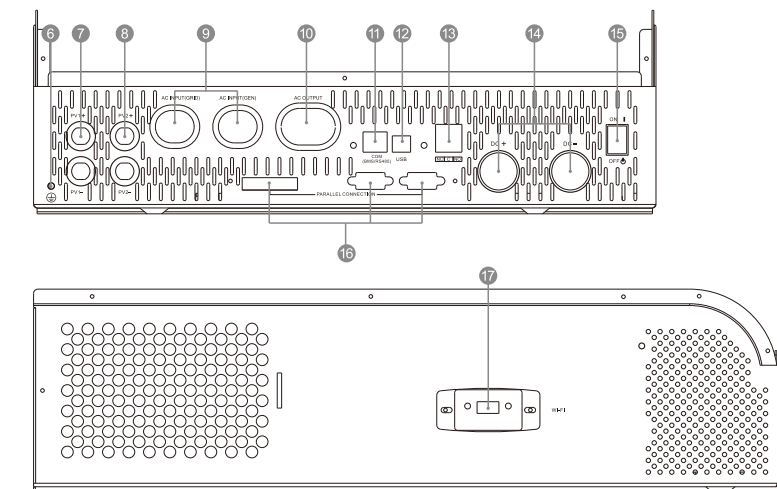
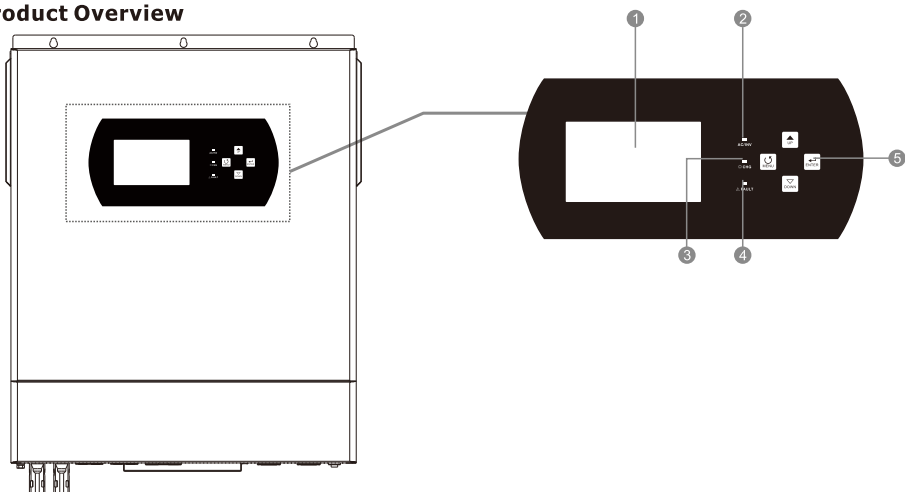

Figure 1 Hybrid Power System

Product Overview



- | | |
|-----------------------|---|
| 1. LCD display | 10. AC output |
| 2. Status indicator | 11. RS485/BMS communication port |
| 3. Charging indicator | 12. USB port |
| 4. Fault indicator | 13. Dry contact |
| 5. Function buttons | 14. Battery Input |
| 6. Ground | 15. Power ON/OFF Switch |
| 7. PV1 | 16. Parallel communication port (only for parallel model) |
| 8. PV2 | 17. Wifi port |
| 9. AC input | |

INSTALLATION

Unpacking and Inspection

Before installation, please inspect the unit. Be sure that nothing inside the package is damaged. You should have received the following items inside of package:

- The unit x 1
- User manual x 1
- USB cable x 1

Preparation

Before connecting all wirings, please take off bottom cover by removing screws as shown below.

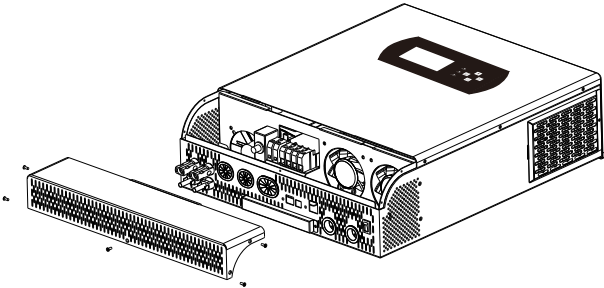

Mounting the Unit

Consider the following points before selecting where to install:

- Do not mount the inverter on flammable construction materials.
- Mount on a solid surface.
- Install this inverter at eye level in order to allow the LCD display to be read at all times.
- For proper air circulation to dissipate heat, allow a clearance of approx. 200 mm to the side and approx. 300 mm above and below the unit.
- The ambient temperature should be between 0°C and 55°C to ensure optimal operation.
- The recommended installation position is to be adhered to the wall vertically.
- Be sure to keep other objects and surfaces as shown in the diagram to guarantee sufficient heat dissipation and to have enough space for removing wires

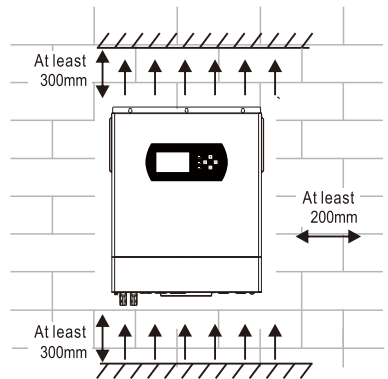

SUITABLE FOR MOUNTING ON CONCRETE OR OTHER NON-COMBUSTIBLE SURFACE ONLY.

Install the unit by screwing three screws

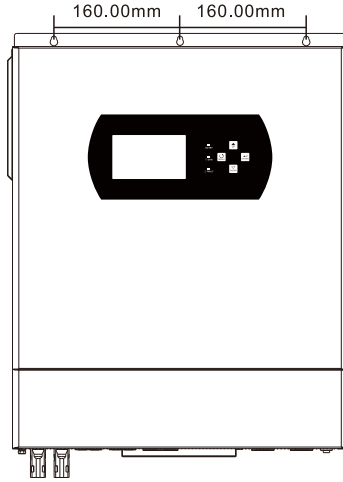

Battery Connection

CAUTION: For safety operation and regulation compliance, it's requested to install a separate DC over-current protector or disconnect device between battery and inverter. It may not be requested to have a disconnect device in some applications, however, it's still requested to have over-current protection installed. Please refer to typical amperage in below table as required fuse or breaker size.

WARNING! All wiring must be performed by a qualified personnel.

WARNING! It's very important for system safety and efficient operation to use appropriate cable for battery connection. To reduce risk of injury, please use the proper recommended cable and terminal size as below.

Ring terminal:

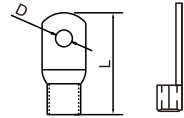

Recommended battery cable and terminal size:

Model	Typical Amperage	Battery Capacity	Wire Size	Cable mm ² (each)	Ring Terminal Dimensions		Torque Value
					D(mm)	L(mm)	
8KW DC48V	160A	200AH	1*1/0AWG	53	8.4	43.2	5 Nm
10KW DC48V	200A	200AH	1*3/0AWG	85	8.4	50.2	5 Nm
11KW DC48V	210A	250AH	1*3/0AWG	85	8.4	50.2	5 Nm
12KW DC48V	220A	250AH	1*3/0AWG	85	8.4	50.2	5 Nm

Please follow below steps to implement battery connection:

1. Assemble battery ring terminal based on recommended battery cable and terminal size.
2. Connect all battery packs as units requires. It's suggested to connect at least 200Ah capacity battery for 8KW-10KW model; at least 250Ah capacity battery for 11KW-12KW.

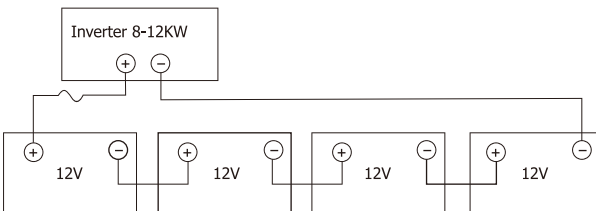

3. Insert the ring terminal of battery cable flatly into battery connector of inverter and make sure the bolts are tightened with torque of 5 Nm. Make sure polarity at both the battery and the inverter/charge is correctly connected and ring terminals are tightly screwed to the battery terminals.

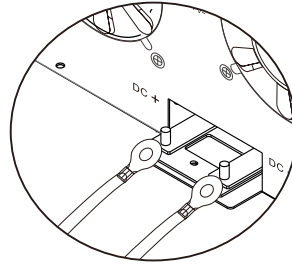

WARNING: Shock Hazard
Installation must be performed with care due to high battery voltage in series.

CAUTION!! Do not place anything between the flat part of the inverter terminal and the ring terminal. Otherwise, overheating may occur.
CAUTION!! Do not apply anti-oxidant substance on the terminals before terminals are connected tightly.
CAUTION!! Before making the final DC connection or closing DC breaker/disconnector, be sure positive (+) must be connected to positive (+) and negative (-) must be connected to negative (-).

AC Input/Output Connection

CAUTION!! Before connecting to AC input power source, please install a separate AC breaker between inverter and AC input power source. This will ensure the inverter can be securely disconnected during maintenance and fully protected from over current of AC input. The recommended spec of AC breaker is 70A for 8-12KW.

CAUTION!! There are two terminal blocks with "IN" and "OUT" markings. Please do NOT-misconnect input and output connectors.

WARNING! All wiring must be performed by a qualified personnel.

WARNING! It's very important for system safety and efficient operation to use appropriate cable for AC input connection. To reduce risk of injury, please use the proper recommended cable size as below.

Suggested cable requirement for AC wires

Model	Gauge	Torque Value
8-12KW DC48V	8 AWG	1.4~ 1.6Nm

Please follow below steps to implement AC input/output connection:

1. Before making AC input/output connection, be sure to open DC protector or disconnecter first.
2. Remove insulation sleeve 10mm for twelve conductors. And shorten phase L and neutral conductor N 3mm.
3. Insert AC input wires according to polarities indicated on terminal block and tighten the terminal screws.
Be sure to connect PE protective conductor (⊕) first.

- ⊕ → **Ground (yellow-green)**
- L1 → **LINE (brown or black)**
- N1 → **Neutral (blue)**

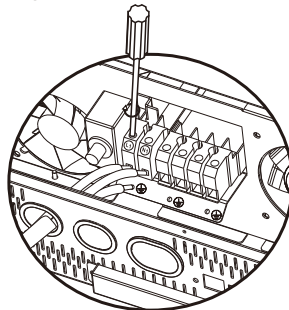

WARNING: Be sure to that AC power source is disconnected before attempting to hardwire it to the unit.

4. Then, insert AC output wires according to polarities indicated on terminal block and tighten terminal screws.
Be sure to connect PE protective conductor (⊕) first.
This inverter is equipped with dual-output. There are four terminals (L1/N1, L2/N2) available on output port. It is to set up through LCD program or monitoring software to turn on and off the second output.
Refer to "LCD setting" section for the details.

- ⊕ → **Ground (yellow-green)**
- L1 → **LINE (brown or black)**
- N1 → **Neutral (blue)**
- L2 → **LINE (brown or black)**
- N2 → **Neutral (blue)**

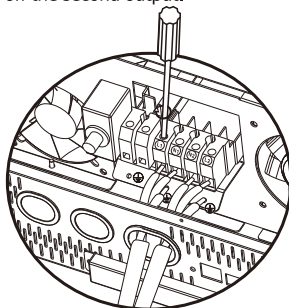

5. Make sure the wires are securely connected.

CAUTION: Important
Be sure to connect AC wires with correct polarity. If L and N wires are connected reversely, it may cause utility short-circuited when these inverters are worked in parallel operation.

CAUTION: Appliances such as air conditioner are required at least 2~3 minutes to restart because it's required to have enough time to balance refrigerant gas inside of circuits. If a power shortage occurs and recovers in a short time, it will cause damage to your connected appliances. To prevent this kind of damage, please check manufacturer of air conditioner if it's equipped with time-delay function before installation. Otherwise, this inverter/charger will trig overload fault and cut off output to protect your appliance but sometimes it still causes internal damage to the air conditioner.

PV Connection

CAUTION: Before connecting to PV modules, please install separately a DC circuit breaker between inverter and PV modules.

WARNING! All wiring must be performed by a qualified personnel.

WARNING! It's very important for system safety and efficient operation to use appropriate cable for PV module connection. To reduce risk of injury, please use the proper recommended cable size as below.

Model	Typical Amperage	Cable Size	Torque Value
8KW DC48V	18A/18A	10AWG	1.4 ~ 1.6 Nm
10-12KW DC48V	27A/27A	10AWG	1.4 ~ 1.6 Nm

PV Module Selection:

When selecting proper PV modules, please be sure to consider below parameters:

1. Open circuit Voltage (Voc) of PV modules not exceeds max. PV array open circuit voltage of inverter.
2. Open circuit Voltage (Voc) of PV modules should be higher than the start-up voltage.
3. Max. Power Voltage (Vmpp) of PV modules should be close to best Vmp of inverter or within Vmp range to get best performance. If one PV module can not meet this requirement, it's necessary to have several PV modules in series connection. Refer to below table.

Note:* Vmp: panel max power point voltage.

The PV charging efficiency is maximized while PV system voltage is close to Best Vmp.

Maximum PV module numbers in Series: Vmpp of PV module*X pcs = Best Vmp or Vmp range of inverter.

PV module numbers in Parallel: Max. charging current of inverter/Imp

Total PV module numbers=maximum PV module numbers in series*PV module numbers in parallel

Solar Charging Mode	
INVERTER MODEL	8-12KW DC48V
Max. PV Array Open Circuit Voltage	500Vdc max(single model)/450Vdc max(parallel model)
PV Array MPPT Voltage Range	90~450Vdc max(single model)/90~430Vdc max(parallel model)
MPPT Number	2
Start-up Voltage(VOC)	80Vdc

Recommended PV module configuration(per independent MPPT)

PV Module Spec(reference)	Total input power	Solar input1 + Solar input2	Qty of modules
Maximum power(Pmax):330W Max.Power Voltage(Vmpp):38.70V Max.Power Current(Imp):8.54A Open Circuit Voltage(Voc):46.1V Short Circuit Current(Isc):9.17A	1320W	4 pieces in series + open	4pcs
		open + 4 pieces in series	
	1980W	6 pieces in series + open	6pcs
		open + 6 pieces in series	
	2640W	8 pieces in series +open	8pcs
		open + 8 pieces in series	
		4 pieces in series + 4 pieces in series	
	3960W	6 pieces in series,2 strings in parallel+open	12pcs
		open + 6 pieces in series,2 strings in parallel	
		6 pieces in series + 6 pieces in series	
	5280W	8 pieces in series,2 strings in parallel+open	16pcs
		open + 8 pieces in series,2 strings in parallel	
		8 pieces in series + 8 pieces in series	
	5940W	9 pieces in series,2 strings in parallel + open	18pcs
open + 9 pieces in series,2 strings in parallel			
9 pieces in series + 9 pieces in series			
6600W	5 pieces in series,2 strings in parallel + 5 pieces in series,2 strings in parallel	20pcs	
7920W	6 pieces in series,2 strings in parallel + 6 pieces in series,2 strings in parallel	24pcs	
9240W	7 pieces in series,2 strings in parallel + 7 pieces in series,2 strings in parallel	28pcs	
10560W	8 pieces in series,2 strings in parallel + 8 pieces in series,2 strings in parallel	32pcs	
11880W	9 pieces in series,2 strings in parallel + 9 pieces in series,2 strings in parallel	36pcs	

Please follow below steps to implement PV module connection:

Connecting DC Input Power Cables

Step1 Remove cable glands from the positive and negative connectors.

Step2 Take out metal terminals from accessory package ,Wiring as illustrated in image.

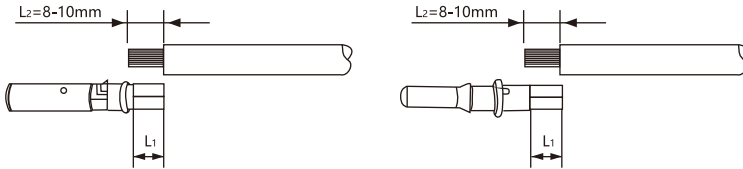

Step3 Insert the positive and negative power cables into corresponding cable glands.

Step4 Insert the stripped positive and negative power cables into the positive and negative metal terminals respectively and crimp them using a crimping tool. Ensure that the cables are crimped until they cannot be pulled out by force less than 400 N, as shown in image.

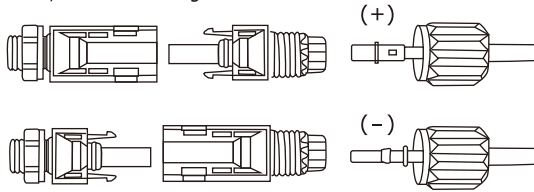

Step5 Insert the positive and negative connectors into corresponding DC input terminals of the Inverter until you hear a "click" sound.

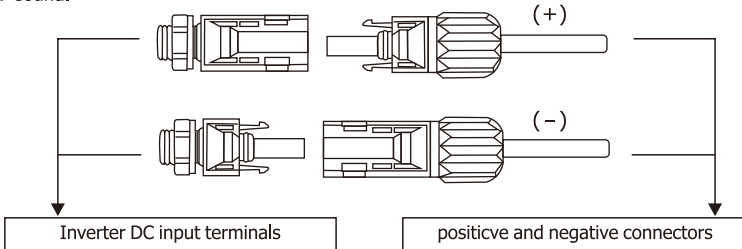

Conditions for DC Connection

The Inverter single-phase inverter has 2 independent input : input A & input B

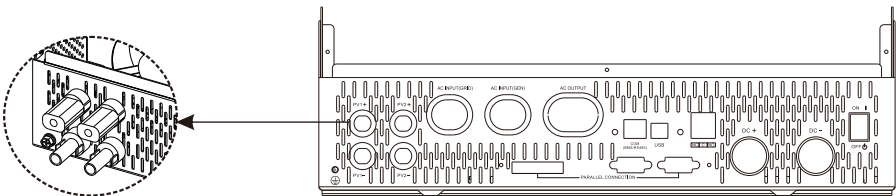

The diagram drawing of DC side is shown as below, notice that the connectors are in paired (male and female connectors). The connectors for PV arrays and inverters are H4 (yunfan) connectors;

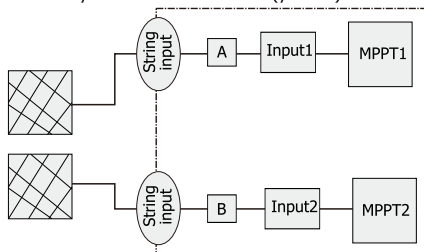

Suggestions for the PV modules of the connected strings:

- ▶ Same type
- ▶ Same quantity of PV modules connected in series

Final Assembly

After connecting all wirings, please put bottom cover back by screwing screws as shown below.

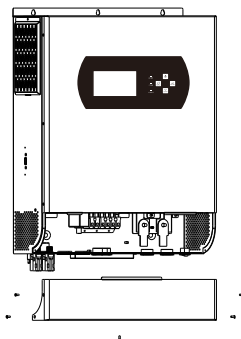

Communication Connection

Please use supplied communication cable to connect inverter and PC. Download the software by link on the first page of this manual into computer and follow on screen instruction to install the monitoring software.

For the detailed software operation, please consult the seller if you have any questions.

WARNING: It's forbidden to use network cable as the communication cable to directly communicate with the PC port or battery with BMS. Otherwise, the internal components of the controller will be damaged.

WARNING: RJ45 interface is only suitable for the use of the company's supporting products or professional operation.

Below chart show RJ45 Pins definition

Pin	Definition	Function
1	RS-485-B	PC communication
2	RS-485-A	
3	GND	
4	CANH	BMS communication
5	CANL	
6		
7		
8		

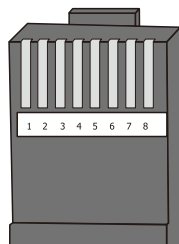

Dry Contact Signal

There is one dry contact (3A/250VAC) available on the rear panel. It could be used to deliver signal to external device when battery voltage reaches warning level.

Unit status	Condition		Dry contact port:		
			NC&C	NO&C	
Power Off	Unit is off and no output is powered		Close	Open	
Power On	Output is powered from Utility		Close	Open	
	Output is powered from Battery or Solar	Program 01 set as utility	Battery voltage < Setting value in Program 19	Open	Close
			Battery voltage > Setting value in Program 21 or Program 39 or battery charging reaches floating stage	Close	Open
		Program 01 set as SBU, SUB, SOL	Battery voltage < Setting value in Program 20 or Program 38	Open	Close
		Battery voltage > Setting value in Program 21 or Program 39 or battery charging reaches floating stage	Close	Open	

Power ON/OFF

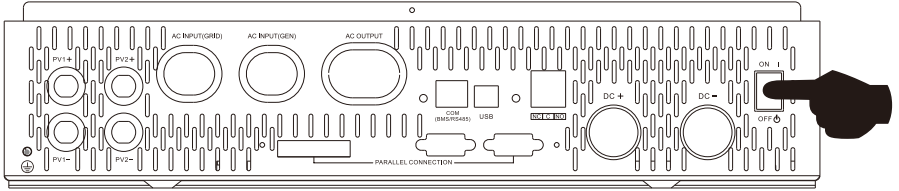

Once the unit has been properly installed and the batteries are connected well, simply press On/Off switch (located on the bottom of the case) to turn on the unit.

Operation and Display Panel

The operation and display panel, shown in below chart, is on the front panel of the inverter. It includes three indicators, four function keys and a LCD display, indicating the operating status and input/output power information.

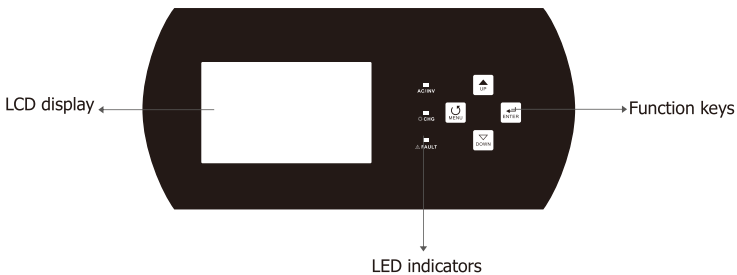

LED Indicator

LED Indicator		Messages	
AC/ INV	Green	Solid On	Output is powered by grid in Line mode.
		Flashing	Output is powered by battery or PV in battery mode.
CHG	Yellow	Flashing	Battery is charging or discharging.
FAULT	Red	Solid On	Fault occurs in the inverter.
		Flashing	Warning condition occurs in the inverter.

Function Keys

Function Keys	Description
MENU	Enter reset mode or setting mode go to previous selection.
UP	Increase the setting data.
DOWN	Decrease the setting data.
ENTER	Enter setting mode and Confirm the selection in setting mode go to next selection or exit the reset mode.

LCD Display Icons

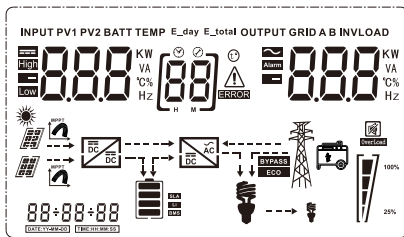



Icon	Function description														
Input Source Information and Output Information															
	Indicates the AC information														
	Indicates the DC information														
	Indicate input voltage, input frequency, PV voltage, battery voltage and charger current. Indicate output voltage, output frequency, load in VA, load in Watt and discharging current.														
Configuration Program and Fault Information															
	Indicates the setting programs														
	Indicates the warning and fault codes. Warning: flashing with warning code. Fault: lighting with fault code.														
Battery Information															
	Indicates battery level by 0-24%, 25-49%, 50-74% and 75-100% in battery mode and charging status in line mode.														
In AC mode, it will present battery charging status.															
<table border="1"> <thead> <tr> <th>Status</th> <th>Battery voltage</th> <th>LCD Display</th> </tr> </thead> <tbody> <tr> <td rowspan="4">Constant Current mode/Constant Voltage mode</td> <td><2V/cell</td> <td>4 bars will flash in turns</td> </tr> <tr> <td>2V/cell~2.083v/cell</td> <td>Bottom bar will be on and the other three bars will flash in turns.</td> </tr> <tr> <td>2.083V/cell~2.167V/cell</td> <td>Bottom two bars will be on and the other two bars will flash in turns.</td> </tr> <tr> <td>>2.167V/cell</td> <td>Bottom three bars will be on and the top bar will flash.</td> </tr> <tr> <td colspan="2">Batteries are fully charged.</td> <td>4 bars will be on.</td> </tr> </tbody> </table>	Status	Battery voltage	LCD Display	Constant Current mode/Constant Voltage mode	<2V/cell	4 bars will flash in turns	2V/cell~2.083v/cell	Bottom bar will be on and the other three bars will flash in turns.	2.083V/cell~2.167V/cell	Bottom two bars will be on and the other two bars will flash in turns.	>2.167V/cell	Bottom three bars will be on and the top bar will flash.	Batteries are fully charged.		4 bars will be on.
Status	Battery voltage	LCD Display													
Constant Current mode/Constant Voltage mode	<2V/cell	4 bars will flash in turns													
	2V/cell~2.083v/cell	Bottom bar will be on and the other three bars will flash in turns.													
	2.083V/cell~2.167V/cell	Bottom two bars will be on and the other two bars will flash in turns.													
	>2.167V/cell	Bottom three bars will be on and the top bar will flash.													
Batteries are fully charged.		4 bars will be on.													

In battery mode, it will present battery capacity.				
Load Percentage	Battery Voltage		LCD Display	
Load > 50%	<1.717V/cell			
	1.717V/cell~1.8V/cell			
	1.8V/cell~1.883V/cell			
	>1.883 V/cell			
50%> Load>20%	<1.817V/cell			
	1.817V/cell~1.9V/cell			
	1.9 V/cell ~1.983V/cell			
	>1.983 V/cell			
Load<20%	<1.867V/cell			
	1.867V/cell~1.95V/cell			
	1.95V/cell~2.033V/cell			
	>2.033 V/cell			
Load Information				
	Indicates overload.			
	Indicates the load level by 0-24%, 25-49%, 50-74% and 75-100%.			
	0%~24%	25%~49%	50%~74%	75%~100%
Mode Operation Information				
	Indicates unit connects to the mains.			
	Indicates unit connects to the PV panel.			
BYPASS	Indicates load is supplied by utility power.			
	Indicates the solar charger circuit is working.			
	Indicates the DC/AC inverter circuit is working.			
Mute Operation				
	Indicates unit alarm is disabled.			

LCD Setting

After pressing and holding "ENTER" button for 2 seconds, the unit will enter setting mode. Press "UP" or "DOWN" button to select setting programs. And then, press "ENTER" or "MENU" button to confirm the selection and exit.

Setting Programs:

Program	Description	Selectable option	
00	Exit setting mode	Escape 	
01	Output source priority selection	(default) 	Solar energy provides power to the loads as first priority, If solar energy is not sufficient to power all connected loads, Utility energy will supply power to the loads at the same time. The battery energy will supply power to the load only in the condition of the utility is unavailable. If the solar is unavailable, the utility will charge the battery until the battery voltage reaches the setting point in program 21. If the solar is available, but the battery voltage is lower than the setting point in program 20, the utility will charge the battery until the battery voltage reaches the setting point in program 20 to protect the battery from damage.
			Solar energy provides power to the loads as first priority, If solar energy is not sufficient to power all connected loads, battery energy will supply power to the loads at the same time. Utility provides power to the loads only when battery voltage drops to either low-level warning voltage or the setting point in program 20 or solar and battery is not sufficient. The battery energy will supply power to the load in the condition of the utility is unavailable or the battery voltage is higher than the setting point in program 21 (when BLU is selected) or program 20 (when LBU is selected). If the solar is available, but the battery voltage is lower than the setting point in program 20, the utility will charge the battery until the battery voltage reaches the setting point in program 20 to protect the battery from damage.

		[0] SOL	<p>Solar energy provides power to the loads as first priority.</p> <p>If battery voltage has been higher than the setting point in program 21 for 5 minutes, and the solar energy has been available for 5 minutes too, the inverter will turn to battery mode, solar and battery will provide power to the loads at the same time.</p> <p>When the battery voltage drops to the setting point in program 20, the inverter will turn to bypass mode, utility provides power to the load only, and the solar will charge the battery at the same time.</p>
		[0] UT	<p>Utility will provide power to the loads as first priority. Solar and battery energy will provide power to the loads only when utility power is not available.</p>
02	AC input voltage range	Appliances (default) [02] APPL	If selected, acceptable AC input voltage range will be within 90-280VAC.
		UPS [02] UPS	If selected, acceptable AC input voltage range will be within 170-280VAC.
		GEN [02] GEN	When the user uses the device to connect the generator, select the generator mode.
		VDE [02] VDE	If selected, acceptable AC input voltage range will conform to VDE4105 (184VAC-253VAC)
03	Output voltage	[03] 230 _v	Set the output voltage (220VAC-240VAC)
04	Output frequency	50Hz(default) [04] 500 _{Hz}	60Hz [04] 600 _{Hz}
		The inverter needs to be restarted after the frequency modification.	
05	Solar supply priority	(default) [05] BLU	<p>Solar energy provides power to charge battery as first priority.</p> <p>When the utility is available, if the battery voltage is lower than the setting point in program 21, the solar energy will never supply to the load or feed into the grid, only charge the battery.</p> <p>If the battery voltage is higher than the setting point in program 21, the solar energy will supply to the load or feed into the grid or recharge the battery.</p>
		[05] LBU	<p>Solar energy provides power to the loads as first priority.</p> <p>If the battery voltage is lower than the setting point in program 20, the solar energy will never supply to the load or feed into the grid, only charge the battery.</p> <p>If the battery voltage is higher than the setting point in program 20, the solar energy will supply to the load or feed into the grid or recharge the battery.</p>

06	Overload bypass: When enabled, the unit will transfer to line mode if overload occurs in battery mode.	Bypass disable [06] bYd	Bypass enable(default) [06] bYE
07	Auto restart when overload occurs	Restart disable(default) [07] Lt-d	Restart enable [07] LtE
08	Auto restart when over temperature occurs	Restart disable(default) [08] t-d	Restart enable [08] tE
10	Charger source priority: To configure charger source priority	If this inverter/charger is working in Line, Standby or Fault mode, charger source can be programmed as below:	
		Solar first [10] C50	Solar energy will charge battery as first priority. Utility will charge battery only when solar energy is not available.
		Solar and Utility(default) [10] 5NU	Solar energy and utility will charge battery at the same time.
		Only Solar [10] 050	Solar energy will be the only charger source no matter utility is available or not
		If this inverter/charger is working in Battery mode, only solar energy can charge battery. Solar energy will charge battery if it's available and sufficient.	
11	Maximum charging current: To configure total charging current for solar and utility chargers.(Max. charging current =utility charging current + solar charging current)	80A (default) [11] 80 ^A	Setting range is from 1A to 120A for 8KW model and from 1A to 150A for 10-12KW model.Increment of each click is 1A.
13	Maximum utility charging current	30A (default) [13] 30 ^A	Setting range is from 1A to 120A for 8KW model and from 1A to 150A for 10-12KW model.Increment of each click is 1A.
14	Battery type	AGM (default) [14] AGd	Flooded [14] FLd
		GEL [14] GEL	LEAD [14] LEA
		Lithium Ion [14] LI	User-Defined [14] USE
		If "User-Defined" or "LI" is selected,When the lithium battery and the inverter do not communicate properly,the battery icon  will flash. If "LI" is selected and the battery icon does not flash,program of 11,17,18 will be set automatically,program of 19,37 will be set to SOC percentage method and program of 11,17,18,37 can not be changed by user. If "User-Defined" is selected and the battery icon does not flash,battery charge voltage,charge current and BMS control method can be set up in program 11,17,18,19,37.	
17	Bulk charging voltage (C.V voltage)	48V model default setting: 56.4V [17] CV 56.4 ^V	Setting range is from 48.0V to 58.4V for 48Vdc model. Increment of each click is 0.1V.

18	Floating charging voltage	48V model default setting: 54.0V [18]FLV 54.0 ^v	
		Setting range is from 48.0V to 58.4V for 48Vdc model. Increment of each click is 0.1V.	
19	Low DC cut-off voltage or SOC percentage	48V model default setting: 42V [19]COV 42 ^v	
		If "User-Defined" or "LI" is selected in program 14, this program can be set up. Setting range is from 42.0V to 54.0V for 48Vdc model. Increment of each click is 0.1V. Low DC cut-off voltage will be fixed to setting value no matter what percentage of load is connected.	
		SOC 10% (default) SOC [19] 10 %	
If "User-Defined" or "LI" is selected in program 14, and the SOC percentage method is selected in program 37, the low DC cut-off SOC percentage will be able to be set. Low DC cut-off SOC percentage will be fixed to setting value no matter what percentage of load is connected. Setting range is from 0%-90%. Increment of each click is 1%.			
20	Battery stop discharging voltage when grid is available	Available options for 48V models: 48.0V (default)	
		[20]48.0 ^v	Setting range is from 44.0V to 58.0V. Increment of each click is 0.1V.
21	Battery stop charging voltage when grid is available	Available options for 48V models: 54.0V (default)	
		[21]54.0 ^v	Setting range is from 44.0V to 58.0V. Increment of each click is 0.1V.
22	Auto turn page	(default) [22]PTE	If selected, the display screen will auto turn the display page.
		[22]Ptd	If selected, the display screen will stay at latest screen user finally switches.
23	Backlight control	Backlight on [23]LON	Backlight off (default) [23]LOF
		Alarm on (default) [24]6ON	Alarm off [24]6OF
24	Alarm control	Alarm on [25]AON	Alarm off (default) [25]AOF
		Record enable (default) [27]FON	Record disable [27]FOF
27	Record Fault code	Record enable (default) [27]FON	Record disable [27]FOF
		Saving mode disable (default) [29]SdS	If disable, no matter connected load is low or high, the on/off status of inverter output will not be effected.
29	Power saving mode enable/disable	Saving mode enable [29]SEn	If enable, the output of inverter will be off when connected load is pretty low or not detected.























30	Battery equalization	Battery equalization [30] EEN	Battery equalization disable(default) [30] Ed5
31	Battery equalization voltage	Available options for 48V models:57.6V [31] E ^v 57.6 ^v	
		Setting range is from 48.0V to 58.4V.Increment of each click is 0.1V.	
33	Battery equalization time	60min(default) [33] 60	Setting range is from 5 min to 900 min. Increment of each click is 5 min.
34	Battery equalization timeout	120min(default) [34] 120	Setting range is from 5 min to 900 min. Increment of each click is 5 min.
35	Equalization interval	30days(default) [35] 30d	Setting range is from 0 to 90 days. Increment of each click is 1 day.
36	Equalization activated immediately	Enable [36] AEN	Disable(default) [36] Ad5
		If equalization function is enabled in program 30, this program can be set up. If "Enable" is selected in this program, it's to activate battery equalization immediately and LCD main page will shows "E ^v ". If "Disable" is selected, it will cancel equalization function until next activated equalization time arrives based on program 35 setting. At this time, "E ^v " will be shown in LCD main page too.	
37	BMS control method	Voltage method(default) [37] 40L	SOC Percentage method [37] 50C
38	Battery stop discharging percent When SOC is available	20%(default) [38] 20 %	Setting range is from 5%-95% Increment of each click is 1% .
39	Battery stop charging percent When SOC is available	95%(default) [39] 95 %	Setting range is from 10%-100% Increment of each click is 1%.
40	BMS communication	(default) [40] ,dP	when the communication between BMS and converter is faulted ,the converter still charge or discharge from the battery .
		[40] U ⁿ 1	when the communication between BMS and converter is faulted ,the converter stop charging or discharging from the battery .
41	Lithium battery protocol	SEL [41] 17	Setting range is from 0 to 31 Increment of each click is 1
		If LI is selected in program 14, program 41 can be set. After the program 41 is set, please restart the inverter to take effect. For example, if you set the program 41 to 17, the inverter can communicate with the must lithium battery.	
		41 Setting items	Communication protocol
		0	Must Old
		1	Dyness
		5	Ultracell
		7	Vision
		8	Pylon
		17	Must New
			Communication mode
			CAN
			CAN
			RS485
			RS485
			CAN
			CAN









42	Parallel address Setting (After the program is set, please restart the inverter to take effect. Before confirming that the settings are in effect, please disconnect the connection between the machine outputs)	Single: This inverter is used in single phase application 	Parallel: This inverter is operated in parallel system (you can set the first machine to 1P1, the second machine to 1P2, the third machine to 1P3, and so on)
		When the inverter is operated in 3-phase application, set up inverter to be operated in specific phase	
		A phase: (you can set the first machine in phase A to 3A1) 	B phase: (you can set the first machine in phase B to 3B1)
		C phase: (you can set the first machine in phase C to 3C1) 	
48	photovoltaic panel configuration	AL0 (default) 	If you connect PV1 and PV2 to the independent photovoltaic panel.
			If you connect PV1 and PV2 to the same photovoltaic panel.
60	Setting cut-off voltage point or SOC percentage on the second output (L2) if '0' is selected in program 42 (Program 37 setting VOL or SOC)	44.0V (default) 	Setting range is from 44.0V to 58.0V. Increment of each click is 0.1V.
		25% (default) 	Setting range is from 20%-95%. Increment of each click is 1%.
61	Setting discharge time on the second output (L2) if '0' is selected in program 42	Disable (default) 	Setting range is disable and then from 0 min to 990 min. Increment of each click is 1 min.
62	Setting start time for turn on the second output (L2) if '0' is selected in program 42	0 (default) 	Setting range is from 00 to 23. Increment of each click is 1 hour. If setting range is from 00 to 08, the second output will be turned on until 09:00, during this period, it will be turned off if any setting value in program 60 or 61 is reached.
63	Setting end time for turn on the second output (L2) if '0' is selected in program 42	23 (default) 	
95	Time setting – Minute		For minute setting, the range is from 0 to 59.
96	Time setting – Hour		For hour setting, the range is from 0 to 23.
97	Time setting – Day		For day setting, the range is from 1 to 31.
98	Time setting – Month		For month setting, the range is from 1 to 12.
99	Time setting – Year		For year setting, the range is from 1 to 98.

After pressing and holding "MENU" button for 6 seconds, the unit will enter reset model. Press "UP" and "DOWN" button to select programs. And then, press "ENTER" button to exit.















	(default) 	Reset setting disable
		Reset setting enable

Fault Reference Code







Fault Code	Fault Cause	LCD Indication
01	Fan is locked when inverter is off	[01] 
02	Inverter transformer over temperature	[02] 
03	Battery voltage is too high	[03] 
04	Battery voltage is too low	[04] 
05	Output short circuited	[05] 
06	Inverter output voltage is high	[06] 
07	Overload time out	[07] 
08	Inverter bus voltage is too high	[08] 
09	Bus soft start failed	[09] 
11	Main relay failed	[11] 
21	Inverter output voltage sensor error	[21] 
22	Inverter grid voltage sensor error	[22] 
23	Inverter output current sensor error	[23] 
24	Inverter grid current sensor error	[24] 
25	Inverter load current sensor error	[25] 
26	Inverter grid over current error	[26] 
27	Inverter radiator over temperature	[27] 
31	Solar charger battery voltage class error	[31] 
32	Solar charger current sensor error	[32] 
33	Solar charger current is uncontrollable	[33] 
41	Inverter grid voltage is low	[41] 
42	Inverter grid voltage is high	[42] 

43	Inverter grid under frequency	[43] 
44	Inverter grid over frequency	[44] 
51	Inverter over current protection error	[51] 
52	Inverter bus voltage is too low	[52] 
53	Inverter soft start failed	[53] 
55	Over DC voltage in AC output	[55] 
56	Battery connection is open	[56] 
57	Inverter control current sensor error	[57] 
58	Inverter output voltage is too low	[58] 

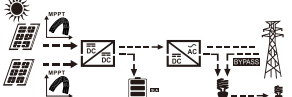
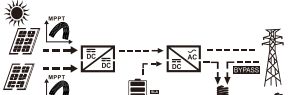
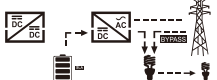
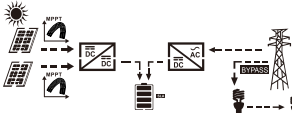
Warning Indicator

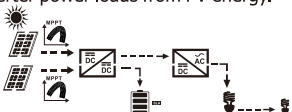
Warning Code	Warning Event	Icon flashing
61	Fan is locked when inverter is on.	[61] 
62	Fan 2 is locked when inverter is on.	[62] 
63	Battery is over-charged.	[63] 
64	Low battery	[64] 
67	Overload	[67]  
70	Output power derating	[70] 
72	Solar charger stops due to low battery	[72] 
73	Solar charger stops due to high PV voltage	[73] 
74	Solar charger stops due to over load	[74] 
75	Solar charger over temperature	[75] 
76	PV charger communication error	[76] 
77	Parameter error	[77] 
90	Lithium battery full (single model)	[90] 

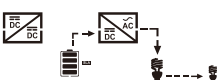
Operating State Description

Operating State	Description	LCD display
<p>Match load state</p> <p>Note: DC power produced from your solar array is converted by the inverter into AC power, which is then sent to your main electrical panel to be used by your household appliances. Any excess power generated is not sold back to the grid, but stored in battery.</p>	<p>PV energy is charger into the battery or converted by the inverter to the AC load</p>	<p>PV energy power is larger than inverter power</p> 
		<p>PV energy power is smaller than inverter power</p> 
		<p>PV is off</p> 
<p>Charge state</p>	<p>PV energy and grid can charge batteries.</p>	
<p>Bypass state</p>	<p>Error are caused by inside circuit error or external reasons such as over temperature, output short circuited and so on.</p>	
<p>Off-Grid state</p>	<p>The inverter will provide output power from battery and PV power.</p>	<p>Inverter power loads from PV energy.</p> 
		<p>Inverter power loads from battery and PV energy.</p> 
		<p>Inverter power loads from battery only.</p> 
<p>Stop mode</p>	<p>The inverter stop working if you turn off the inverter by the soft key or error has occurred in the condition of no grid.</p>	

Display Setting

The LCD display information will be switched in turns by pressing "UP" or "DOWN" key. The selectable information is switched as below order: battery voltage, battery current, inverter voltage, inverter current, grid voltage, grid current, load in Watt, load in VA, grid frequency, inverter frequency, PV voltage, PV charging current, PV charging output voltage, PV charging power .

Selectable information	LCD display	
Battery voltage/DC discharging current	^{BATT} 480 V	480 A
Inverter output voltage/Inverter output current	229 V	^{INV} 130 A
Grid voltage/Grid current	229 V	^{GRID} 80 A
Load in Watt/VA	100 KW	^{LOAD} 120 KVA
Grid frequency/Inverter frequency	^{INPUT} 500 Hz	^{INV} 500 Hz
PV1 voltage and current	^{INPUT PV1} 360 V	806 A
PV2 voltage and current	^{INPUT PV2} 360 V	806 A
PV charger output voltage and PV charging power	^{PV1 PV2} 430 V	^{OUTPUT} 320 KW

SPECIFICATIONS

Table 1 Line Mode Specifications

INVERTER MODEL	8-12KW DC48V
Input Voltage Waveform	Sinusoidal (utility or generator)
Nominal Input Voltage	230Vac
Low Loss Voltage	90Vac±7V(APL,GEN);170Vac±7V(UPS); 186Vac±7V(VDE)
Low Loss Return Voltage	100Vac±7V(APL,GEN);180Vac±7V(UPS); 196Vac±7V(VDE)
High Loss Voltage	280Vac±7V(UPS,APL,GEN); 253Vac±7V(VDE)
High Loss Return Voltage	270Vac±7V(UPS,APL,GEN); 250Vac±7V(VDE)
Max AC Input Voltage	300Vac
Nominal Input Frequency	50HZ/60HZ(Auto detection)
Low Loss Frequency	40HZ±1HZ(UPS,APL,GEN); 47.5HZ±0.5HZ(VDE)
Low Loss Return Frequency	42HZ±1HZ(UPS,APL,GEN); 48.5HZ±0.5HZ(VDE)
High Loss Frequency	65HZ±1HZ(UPS,APL,GEN); 51.5HZ±0.5HZ(VDE)
High Loss Return Frequency	63HZ±1HZ(APL,GEN,UPS); 50.5HZ±0.5HZ(VDE)

Output Short Circuit Protection	Line mode: Circuit Breaker Battery mode: Electronic Circuits
Efficiency (Line Mode)	>95%(Rated R load, battery full charged)
Transfer Time	10ms typical(UPS,VDE) 20ms typical(APL) 50ms typical(For parallel operation)
Output power derating:	230Vac model:  <p>The graph shows Output Power on the vertical axis and Voltage on the horizontal axis. The power is zero until 90V. At 90V, it jumps to 45% of the Rated Power. From 90V to 200V, the power increases linearly to reach the Rated Power. From 200V to 280V, the power remains constant at the Rated Power level.</p>

Table 2 Inverter Mode Specifications

INVERTER MODEL	8KW DC48V	10KW DC48V	11KW DC48V	12KW DC48V
Rated Output Power	8000W	10000W	11000W	12000W
Output Voltage Waveform	Pure Sine Wave			
Output Voltage Regulation	230Vac±5%			
Output Frequency	60Hz or 50Hz			
Peak Efficiency	92%			
Overload Protection	5s@≥110% load; 10s@105%~110% load			
Power Limitation	 <p>The graph shows Power on the vertical axis and Battery Voltage on the horizontal axis. The power is constant at a derated level until 42V. At 42V, it jumps to a higher derated level. From 42V to 55V, the power increases linearly to reach 100% of the Rated Power. From 55V onwards, the power remains constant at the 100% Rated Power level.</p>			
Nominal DC Input Voltage	48Vdc			
Cold Start Voltage	46.0Vdc			

Low DC Warning Voltage @ load < 50% @ load ≥ 50%	46.0Vdc 44.0Vdc
Low DC Warning Return Voltage @ load < 50% @ load ≥ 50%	47.0Vdc 46.0Vdc
Low DC Cut-off Voltage @ load < 50% @ load ≥ 50%	43.0Vdc 42.0Vdc
High DC Recovery Voltage	58Vdc
High DC Cut-off Voltage	60Vdc

Table 3 Charge Mode Specifications

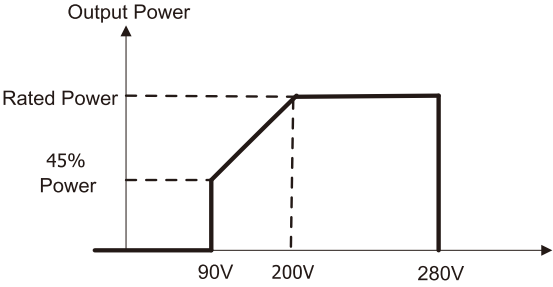
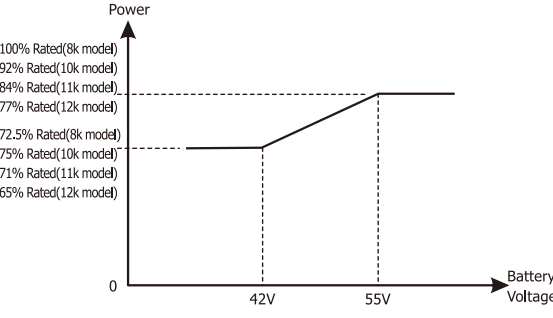
Utility Charging Mode					
INVERTER MODEL		8KW DC48V	10-12KW DC48V		
Nominal Voltage Range for charging		170-260Vac			
Charging Current @ Nominal Input Voltage		120A _{MAX}	150A _{MAX}		
Floating charging voltage	AGM / Gel/LEAD Battery	54.8Vdc			
	Flooded battery	54.8Vdc			
Bulk charging voltage (C.V voltage)	AGM / Gel/LEAD Battery	57.6Vdc			
	Flooded battery	56.8Vdc			
Charging Algorithm		3-Step(Flooded Battery, AGM/Gel/LEAD Battery), 4-Step(LI)			
Solar Charging Mode					
INVERTER MODEL		8KW DC48V	10KW DC48V	11KW DC48V	12KW DC48V
Rated Power		4000W X 2	5000W X 2	5500W X 2	6000W X 2
Maximum PV Input Current		18A X 2	27A X 2(Max 40A)		
Power Limitation					
MPPT charger					
solar charging current		120A _{max}	150A _{max}		
Max.PV Array Open Circuit Voltage		500Vdc max (single model) /450Vdc max (parallel model)			
PV Array MPPT Voltage Range		90~450Vdc (single model) /90~430Vdc (parallel model)			
Min battery voltage for PV charge		34Vdc			

Battery Voltage Accuracy	+/-0.3%			
PV Voltage Accuracy	+/-2V			
Charging Algorithm	3-Step(Flooded Battery, AGM/Gel/LEAD Battery), 4-Step(LI)			
Charging algorithm for lead acid battery				
Charging algorithm for Lithium battery				
Joint Utility and Solar Charging				
INVERTER MODEL	8KW DC48V	10KW DC48V	11KW DC48V	12KW DC48V
Max Charging Current	120A	150A		
Default Charging Current	80A			

Table 4 General Specifications

INVERTER MODEL	8KW DC48V	10KW DC48V	11KW DC48V	12KW DC48V
Safety Certification	CE			
Operating Temperature Range	-10°C to 50°C(>30°C de-rating,1%/°C)			
Storage temperature	-15°C~ 60°C			
Dimension (D*W*H), mm	425*527*145			
Net Weight, kg	18		18.1	

TROUBLE SHOOTING

Problem	LCD/LED/Buzzer	Explanation / Possible cause	What to do
Unit shuts down automatically during startup process.	LCD/LEDs and buzzer will be active for 3 seconds and then complete off.	The battery voltage is too low (< 1.91V/Cell)	1. Re-charge battery. 2. Replace battery.
No response after power on.	No indication.	1. The battery voltage is far too low. (<1.4V/Cell) 2. Battery polarity is connected reversed. Input protector is tripped	1. Check if batteries the wiring are connected and well. 2. Re-charge battery. 3. Replace battery.
Mains exist but the unit works in battery mode.	Input voltage is displayed as 0 on the LCD and green LED is flashing.	Input protector is tripped	Check if AC breaker is tripped and AC wiring is connected well.
	Green LED is flashing.	Insufficient quality of AC power (Shore or Generator)	1. Check if AC wires are too thin and/or too long. 2. Check if generator (if applied) is working well or if input voltage range setting is correct.(Appliance=>wide)
When the unit is turned on, internal relay is switched on and off repeatedly.	LCD display and LEDs are flashing	Battery is disconnected.	Check if battery wires are connected well.
Buzzer beeps continuously and red LED is on.	Fault code 07	Overload error. The inverter is overload 110% and time is up.	Reduce the connected load by switching off some equipment.
	Fault code 05	Output short circuited.	Check if wiring is connected well and remove abnormal load.
	Fault code 02	Internal temperature of inverter component is over 90°C.	Check whether the air flow of the unit is blocked or whether the ambient temperature is too high.
	Fault code 03	Battery is over-charged.	Return to repair center.
		The battery voltage is too high.	Check if spec and quantity of batteries are meet requirements.
	Fault code 01	Fan fault	Replace the fan.
	Fault code 06/58	Output abnormal (Inverter voltage below than 202Vac or is higher than 253Vac)	1. Reduce the connected load. 2. Return to repair center
	Fault code 08/09/53/57	Internal components filed.	Return to repair center
	Fault code 51	Over current or surge	Restart the unit, if the error happens again, please return to repair center.
Fault code 52	Bus voltage is too low		
Fault code 55	Output voltage is unbalanced	Return to repair center.	
Fault code 56	Battery is not connected well or fuse is burnt.	If the battery is connected well, please return to repair center.	

